



M3c

M4b

M5

## **Owner's Manual**

**Monoblock Subwoofer Amplifier**

Thanks you for purchasing Digital Designs amplifiers for your car audio systems and competitions. The M-Class amplifiers are digital monoblock which are engineered for low frequency applications and car audio systems.

The M-Class amps are made to be the soul of your audio system, bass pumping machines, so powerful that your face could be ripped from your head in a momentary lapse of reason.

Well, maybe that's a bit of a stretch, but these amps offer strong power, logical controls and efficient design.

The M-Class amps are single purpose designs with the sole goal of being the best tool for the job. No cutbacks and No wimps

The M-Class amplifiers feature three distinct approaches which are designed for the highest possible efficiency, highest total output and most sound quality bass amplifier.

The high efficiency comes from paying close attention to every stage through the amplifiers' circuit. High speed controller chipsets, efficient power devices, precise thermal management and best engineering are the key to the M-Class.

## 1. FEATURES

Digital Monoblock 1ohm stable amplifiers

	M3c	M4b	M5
Frequency Response	15 - 270Hz	15 - 270Hz	15 - 270Hz
Signal to Noise Ratio	100dB	100dB	100dB
Low Pass Crossover	24dB / Oct	24dB / Oct	24dB / Oct
Low Pass Filter	20 - 200Hz	20 - 200Hz	20 - 200Hz
Subsonic Filter	10 - 50Hz	10 - 50Hz	10 - 50Hz
Bass Boost ( @ 45Hz )	0 - 6dB	0 - 6dB	0 - 6dB
Input Sensitivity	5V - 0.15V	5V - 0.15	5V - 0.15
Master / Slave / Link	Yes	Yes	Yes
Remote control with voltmeter/ clip	Yes	Yes	Yes
Damping Factor	150 <	150 <	150 <
Dimensions ( Inches ) ( 9.134W x 2.519H )	19.685	22.834	27.559

All features are subject to change in the continuing effort to improve the products without notice

Digital Monoblock Output Power

	Power @ 1ohm RMS	Fuse Rating
M3c	3800W x 1	350A ( Linked : 700A )
M4b	5000W x 1	450A ( Linked : 900A )
M5	8000W x 1	700A ( Linked : 1400A )

## 2. DESIGN FEATURES

**M-Class Design Features**

- 1) The M-Class amplifiers are working fully stable down to 4/2/1 ohm as single unit. Daisy chain connection makes it fully stable down to 2 ohm.
- 2) The M-Class has the possible highest efficiency and sufficient amount of the parts to maximize the performance at especially 12V application.

- 3) The M-Class has 4 ways of accurate protection circuit, as speaker short, DC offset, voltage, thermal protection which are the most safe-guard.
- 4) The M-Class is designed in double sided board and uses high current mosfet switching devices.
- 5) The M-Class has 24dB/Oct slope of crossover, Low Pass Filter and Subsonic Filter as fully adjustable.
- 6) The M-Class has dash mount remote level control which allows convenient level control and check the battery voltage as well as clipping indicator from the driver's seat.

### 3. CONTROL & CONNECTION

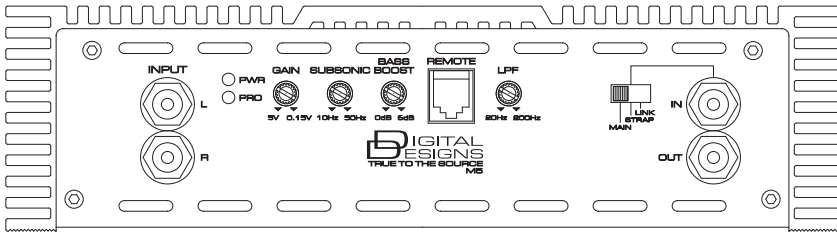

#### INPUT

Connect preamp signal cables from headunit to M-Class amplifier to RCA Input.

#### POWER & PROTECTION INDICATOR

Power LED, Green-lit shows correct operation of M-Class amplifiers. Protect LED, RED-lits shows general malfunction, faulty connection and thermal protection

#### GAIN

Matching the output voltage of the headunit's RCA line-outs to M-Class amplifiers' input section. Its range is 5V to 0.15V.

#### SUBSONIC Crossover FREQUENCY

Control the high Pass point for the speaker outputs to eliminate extreme low frequencies. Its range is 10 - 50 Hz @ 24dB/Oct slope

#### BASS BOOST

It boosts bass to 6dB at 45Hz

#### REMOTE CONTROL

Remote gain control has voltmeter and clipping indicator. When Remote control is powered on, then White color LED lights up DD logo. Voltmeter shows the battery voltage, so check carefully whether battery is full enough to drive the amplifier.

Clipping LED shows the clipping point of M-Class amplifiers.

When M-Class amplifiers are close to clipping point, Clipping LED is starting to clip.

When clipping LED is clipping faster, it is better to turn level down.

If clipping LED is lit on RED, amplifier is protected.

M-Class amplifiers will be on in few minutes later.

#### LPF Crossover FREQUENCY

Controls the low pass point for the speaker outputs.

The crossover range is 20 - 200Hz @ 24dB/Oct Slope

#### MAIN/STRAP LINK

MAIN/STRAP is the strappable function of 2 M-Class amplifier.

Strappable connection minimum working impedance is 2 ohm.

MAIN/LINK is the multiple connection with same signal input.

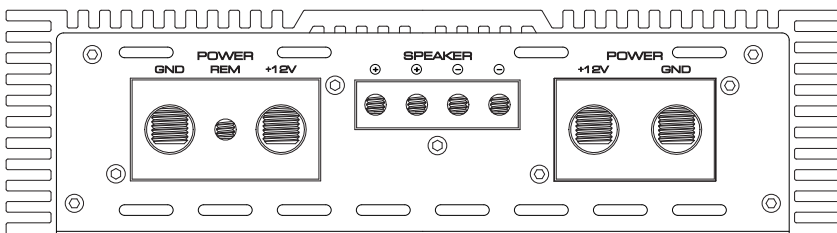

#### GND (GROUND CONNECTION)

It is connected to the Negative or ground cables of the Vehicle. Recommended cable is 0 ga.

#### REM (REMOTE)

It is connected to switched +12V with a trigger cable coming from the head unit

#### +12V (POWER CONNECTION)

This must be connected to the fuse positive terminal (+12V) of the battery. Recommended wire is 0 ga.

#### SPEAKER OUTPUTS

It connects amplifier to speakers. Minimum speaker cable is 12 ga.

Minimum impedance for single unit is 1 ohm.

Minimum impedance in linked use is 2 ohm.

## 4. INSTALLATION

In case you install M-Class amplifiers by yourself, please read owner's manual and follow your installation steps very carefully.

Before you start your installation, please take all steps into consideration.

or, You can have Digital Designs authorized distributors to check installation and turn in your car audio systems

### 4-1. MOUNTING PREPARATION

Disconnect the negative (-) battery cable before mounting M-Class amplifiers or making any connections.

Check the battery and alternator ground (-) connections.

Make sure they are properly connected and free of corrosion.

Before selecting a mounting location for M-Class amplifiers, Pls take some concerns into consideration with cooling efficiency and safety.

### 4-2. MOUNTING PREPARATION

M-Class amplifiers use heavy-duty and good heat radiation heatsink design for avoiding excessive heat from amplifiers' circuitry. But for better heat radiation performance, It is good to find the mounting location, where you can install M-Class amplifiers vertically with the heatsink fins and better air flow around M-Class amplifiers.

For the safety, you have to find dry and well ventilated location and make sure any cables and car equipment are not interfaced with mounting location.

Be sure the mounting location and drilling of pilot cables for mounting will not present a hazard to any cables, control cables, fuel lines, fuel tanks, hydraulic lines or other vehicle systems or components

### 4-3. +12V, GND, REM CONNECTION

#### +12V ( POWER CONNECTION )

Before mounting M-Class amplifiers, disconnect the negative (-) wire from battery to protect any accidental damage to amplifier and audio system.

M-Class amplifiers are designed to use 0 gauge cable for power and ground connection.

Connect the power cable to power terminal labeled as + 12V.

All M-Class amplifiers are not equipped with fuses so you have to install the external fuses on the power cable.

Connect one end of fuse holder to the power cable and the other end of fuse holder to positive battery within 20 cm of the same cable.

This fuse location will protect the system and the vehicle against the possibility of a short circuit in the power cable. Be sure to use fuses and fuse holder adequate for the application.

The fuse ratings are

M3c : 350A for single unit ( 700A for daisy chain connection )

M4b : 450A for single unit ( 900A for daisy chain connection )

M5 : 700A for single unit ( 1400A for daisy chain connection )

## GND ( GROUND CONNECTION )

Locate a secure grounding connection as close to amplifier as possible.  
 Make sure the location is clean and provides a direct electrical connection to the frame of the vehicle.  
 Connect one end of a short piece of the same size cable as the power cable to the grounding point.  
 Run the one end of the cable to the grounding point.  
 Run the other end of the cable to the mounting location  
 Connect the ground cable to the screw terminal labeled as GND.

## REM ( REMOTE CONNECTION )

Run a remote turn on cable from the switched + 12V source .  
 then, you will be using to turn on the system components.  
 This may be a toggle switch, a relay, or your source unit's remote trigger cables, or power antenna  
 trigger cable.  
 Connect the remote turn on cable to the power terminal labeled as REM.

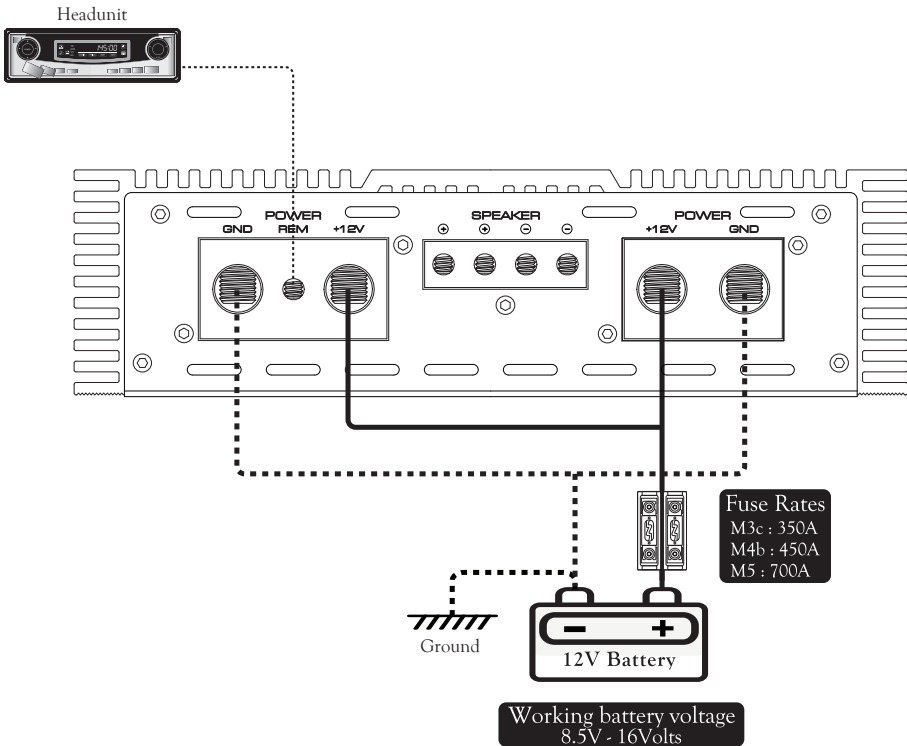

#### 4.4. SPEAKER CONNECTION

M-Class amplifiers are recommended to use 12 gauge speaker connecting cables. Run 12 gauge speaker connecting cables from your speakers to M-Class amplifiers' mounting location.

Keep speaker cables away from power cables and M-Class amplifier's input cables. Use grommets anywhere the cables have to pass through the holes in the metal frame or sheet metal. Connect to the speakers according to the type of the terminals on each speaker.

Strip 3/8" of insulation from the end of each cable and twist the cables strands together tightly. Make sure there is the insulation from the end of each cable and twist the cables together tightly.

Make sure there are no stray strands that might touch other cables or terminals and cause a short circuit.

Crimp spade lugs over the cable ends or tin the ends with solder to provide a secure termination. Connect the cable ends to M-Class amplifiers as speaker system diagram

##### M-CLASS speaker connection diagram i

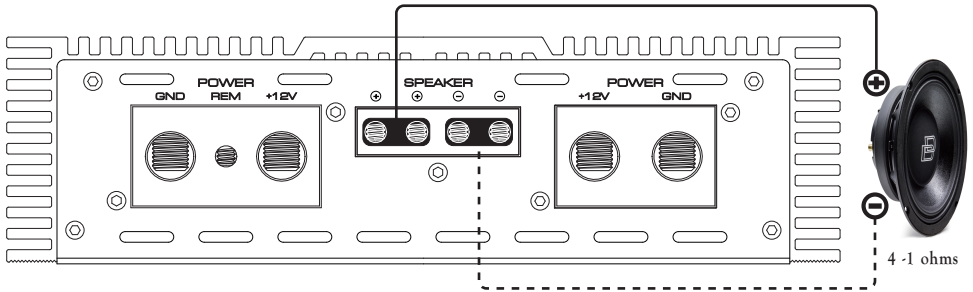

##### M-CLASS speaker connection diagram ii

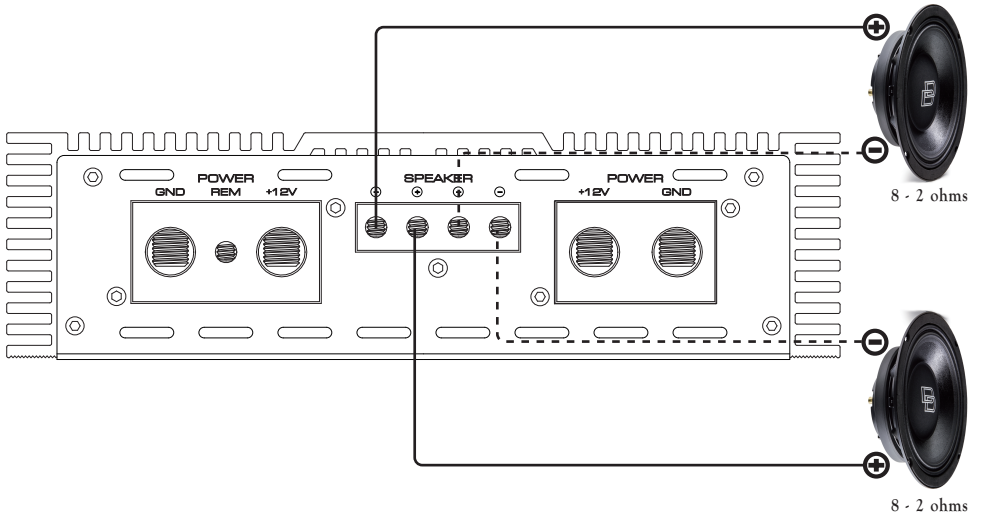

## 4-5. DAISY CHAIN CONNECTION

Daisy chain connection makes 2pcs of same M-Class amplifiers linkable .

Please read the following connection and diagram carefully to make correct connection.

Connect the main amplifier to the head-unit and set its MAIN / STRAP / LINK switch to MAIN position.

Connect the main and strap amplifier as daisy chain rca jack as diagram.

Set Strap amplifier's MAIN / STRAP / LINK switch to STRAP position.

Connect speaker cable (+) on main amplifier to subwoofer (+) terminal.

Connect speaker cable (+) on strap amplifier to subwoofer (-) terminal.

Connect speaker cable (-) on main amplifier to speaker cable (-) on strap amplifier

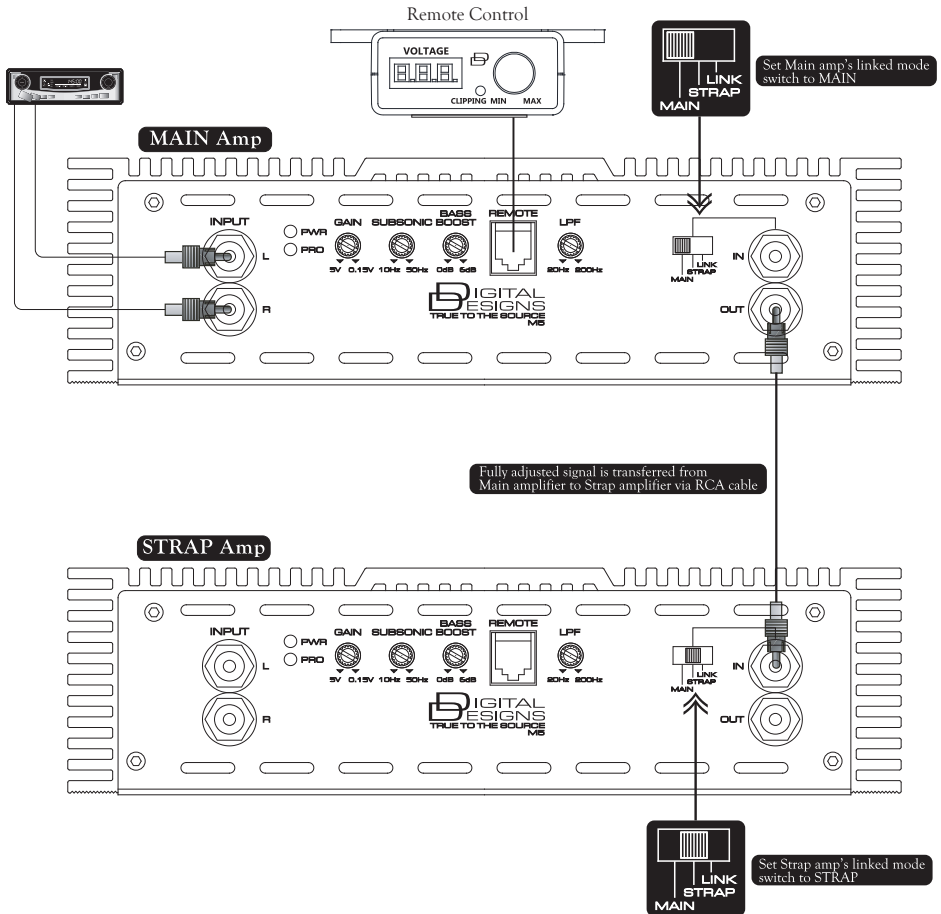

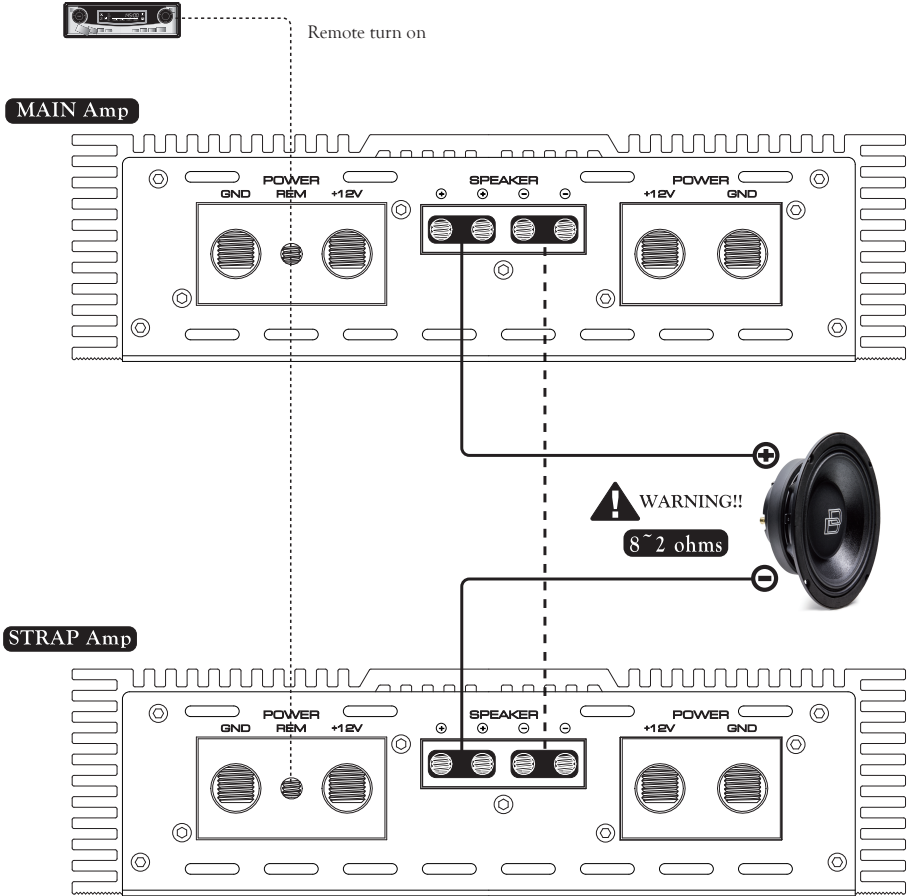

**!** Linked mode minimum working impedance is 2ohms.  
M3c, M4b & M5 working voltage is 8.5V - 16Volts



## 4-6. MULTIPLE CONNECTION ( MAIN / LINK MODE )

In MAIN / LINK MODE

The Entire pre-amp section of link amps is bypassed and feed directly from Main amplifier's pre-amp with MAIN / LINK cable which gives the exact and perfect gain and crossover matching across all amplifiers. The phase of all link amplifiers is not reversed, so all subwoofers will be in phase and each amplifier will be independent in function other than signal.

Set MAIN / LINK switch on each amplifier as shown on the diagram below, you will have one main and unlimited link amplifiers in this configuration.

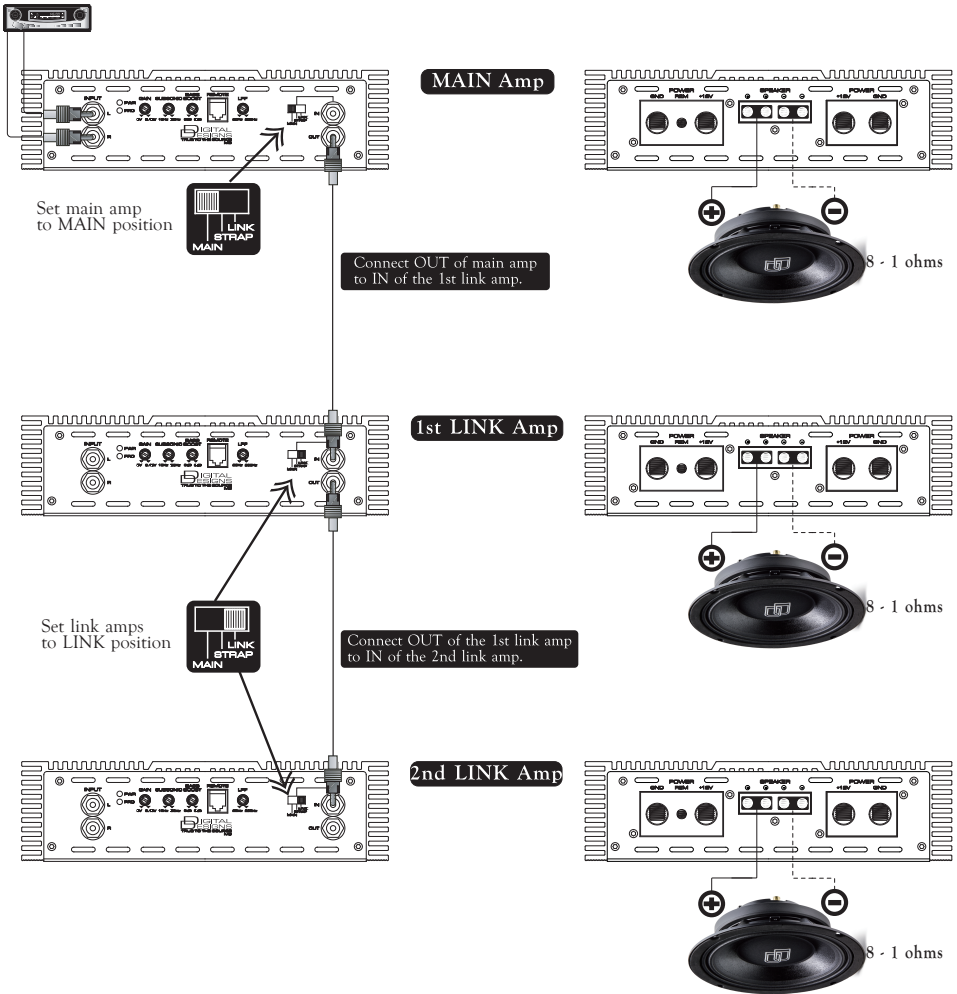

## 5. TROUBLE SHOOTING TIPS

### NO SOUND ( NO OUTPUT )

- @ Pls check all connections, cables' rounting, short, voltage at M-Class and headunit
- @ Pls check fuses ,If they are blown or burnt , pls replace with new one.
- @ Pls check whether speakers work well, you can test speakers by connecting to another amplifier

### PROTECTION

- @ Pls check overload, overheat ( thermal ), short and voltage. DC offset
- @ M-Class minimum working impedance is 1 ohm for single and 2 ohm for linked operation.
- @ If M-Class amplifiers are shut down due to overheat, they will be on some minutes later.
- Pls make better air flow and no obstruction around M-Class for thermal protection
- @ M-Class have Low and high voltage protection. Working Voltage is 8.5V~ 16V.
- so Voltage is lower than 8.5V or higher than 16V, they will be protected.
- @ When over 4V DC comes into M-Class amplifiers, then, they will be DC protected.
- Check whether M-Class amplifiers work after removing RCA-Input
- If M-Class amplifiers work, then check DC by checking RCA-input L and R.
- When DC is over 4V at input, try by replacing headunit or source unit

### DISTORTION

- @ Readjust input level and check the speaker quality at another amplifier.
- If there is still problem, Replace poor quality speakers with good quality ones

### POOR BASS RESPONSE

- @ Pls check speaker cables and reverse polarity of one channel

### BUZZING SOUND

- @ Check M-Class amplifiers and headunit ground contact.
- @ Check Rca Jack and repalce with new one or rerout Rca Jack.

### WHINING NOISE

- @ Engine noise is caused by poor grounding of M-Class amplifiers, headunit, other components, battery or alternator, so pls check all grounding connection.

MEMO



[www.ddaudio.com](http://www.ddaudio.com)



[www.ddaudio.com](http://www.ddaudio.com)