

powerbass®

X T R E M E



XMA-2160IR

XMA-2400IR

XMA-4160IR

XMA-5670IR

XTREME SERIES MINI AMPLIFIER

Owners Manual

Please read through this manual to familiarize yourself with your new amplifier. Should your PowerBass Xtreme mobile amplifier ever require service, you will need to have the original dated receipt.



AMPLIFIERS

Thank you and Congratulations

Thank you for your decision to purchase a PowerBass USA Xtreme mobile amplifier! Our new mini amplifiers are the result of extensive engineering, testing, and bullet proof construction. Their versatility enables compatibility with optional signal and audio processors. These high quality MOSFET amplifiers may be configured to allow maximum flexibility in designing different types of speaker systems.



FULL RANGE CLASS D MINI AMPLIFIERS

The PowerBass XMA Series are high quality MOSFET amplifiers that are capable of running a system full range, or they may be selected only to power subwoofers. It is important that you closely follow the wiring instructions contained in this Owners Manual so that you get the most from your PowerBass Xtreme mobile amplifier.

Δ Caution Δ

High powered audio systems in a vehicle are capable of generating higher than "Live Concert" levels of sound pressure. Continued exposure to excessively high volume sound levels could cause hearing loss or damage. Also, operation of a motor vehicle while listening to audio equipment at high volume levels may impair your ability to hear external sounds such as horns, warning signals, or emergency vehicles—thus creating a potential traffic hazard. In the interest of safety, PowerBass USA highly recommends listening at lower volume levels when driving.

TECHNICAL FEATURES

- FRD (Full Range Class-D) technology
- International Rectifier Chip Set
- Ultra Low Current Draw
- High Damping Control Circuit
- High Efficiency SMD Circuit Technology
- Double Sided Copper Plated PCB
- Digital Sound Optimization Circuitry
- Quiet Switching
- High Current Voltage Ripple Rejection Circuitry
- Virtual Silence Turn On/Off Mute Circuit
- Advanced Protection Circuitry
- Platinum Tiffany RCA Connectors

FRD-FULL RANGE CLASS D TECHNOLOGY

This amplifier represents the very latest in Class D technology. The XMA Series uses the new IR® (International Rectifier) platform which has been under development for the past several years. IR®, a leader in PWM circuit design, has worked in conjunction with PowerBass engineers to produce more stable power output, minimal RF interference and improved sound quality.

The benefits of this cooperative effort are many and include improved temperature, frequency, voltage regulation and drive capability to name a few.

The result to the user is a all around improved product that will provide years of listening enjoyment.

International
IR Rectifier
THE POWER MANAGEMENT LEADER

IR® is a registered trademark of International Rectifier Corporation.

INSTALLATION EXPERIENCE

Installation of PowerBass mobile amplifiers requires detailed knowledge of electronics wiring and proper speaker impedance. We strongly recommend installation by an authorized PowerBass dealer. This Owners Manual only provides general installation and operation instructions. If you have any reservations about your installation skills, please contact your local PowerBass dealer for assistance.

IMPORTANT : This amplifier is designed for operation in vehicles with 12-volt Negative ground electrical systems only.

PREPARING FOR INSTALLATION

NOTE: The tools listed below may be required for basic installation

- An electric drill with bits
- Philips head and standard screwdrivers
- Wire strippers
- Crimping tool
- VOM (electronic volt ohm meter)
- Heat shrink tubing and heat gun
- Soldering iron
- Electronic (Rosen not Acid Core) Solder

INSTALLATION PRECAUTIONS

NOTE: Proceed only if you are a qualified installer, otherwise; see your Authorized PowerBass Dealer to professionally install this amplifier. Always wear protective eyewear when using tools.

- Turn off all stereo and other electrical devices before you begin.
- Disconnect the negative (-) lead from your vehicles battery.
- Locate all fuel lines, brake lines, oil lines, and electrical cables when planning the install.
- Make sure there is at least 2-inches (5 cm) around the air vents on the amplifier.
- When connecting ground points, make sure all paint is carefully scrapped away from the auto body and contact is made with bare metal.
- Use a utility knife to trim away fabric from hole locations before drilling or cutting.
- When running power cables through sheet metal, be sure to use grommets to properly insulate the metal edges from the wire insulation.
- If possible, use tubing through grommets.

WARNING: Check your vehicle's owner's manual before disconnecting the battery. Disconnecting the battery on some vehicles may require an anti-theft code when reconnecting the battery and require the on-board computer to be reset at the dealership. Check with your local dealer if you are uncertain.

MOUNTING THE AMPLIFIER

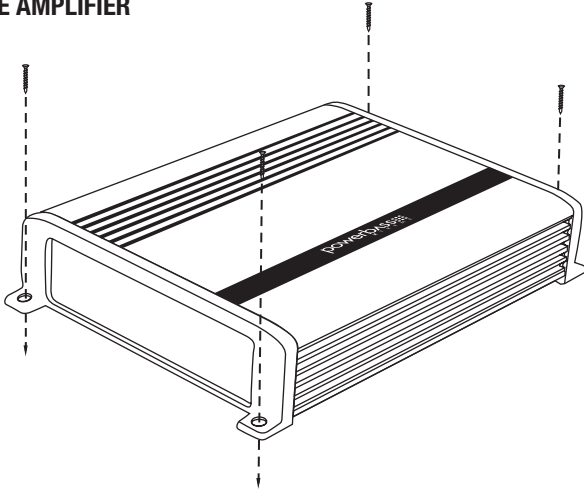

Fig.1 Mounting Amplifier

To keep your PowerBass Xtreme amplifier running at top performance, choosing the proper location is of utmost importance. Both Thermal and Overload protection are built in. In the event of overheating, the amplifier will reduce its power output (volume) to maintain operation. For this reason the amplifier should be mounted in a location which will allow air to circulate freely. The compact size of the PowerBass XMA Series amplifier allows greater flexibility in mounting.

MOUNTING LOCATION

Find a dry, clear and well ventilated area to mount your amplifier that is unobstructed by any objects that will cause harm or block ventilation.

The amplifier should be protected from exposure to moisture and direct sunlight. You may use the amplifier as a template and mark the four screw locations with a felt tip pen. Set the amplifier aside before drilling. Use caution to make sure there are no objects behind the installation surface that may become damaged during drilling.

If mounting under a seat, make sure there is at least 1-inch (2.5 cm) of space above the amplifier's heatsink to permit proper cooling.

The best places to mount your amplifier are: The floor of the trunk, under a seat, or on the back of the rear seat. For alternate installation locations, please consult your authorized PowerBass Dealer.

FUSE REQUIREMENTS

While the panel your PowerBass amplifier incorporates one or more fuses, these do nothing to protect the vehicle from a dangerous short circuit. It is absolutely vital that the main power lead to the amplifier(s) in the system be fused within 18-inches (45cm) of the connection to the vehicle battery. The value of this fuse (or circuit breaker) should be no greater than the sum of the fuses found on all of the equipment being connected to that power wire.

*** WARNING ***

- Do not install in a place where it could injure the driver or passengers if the vehicle stops suddenly.
- Upside down mounting will compromise heat dissipation through the heatsink and could engage the Advanced Protection Circuitry.
- Try to avoid mounting the amplifier on a subwoofer enclosure, as extended exposure to vibration may cause malfunction of the amplifier.
- Don't mount the amplifier so that the wire connections are unprotected or are subject to pinching or damage from nearby objects.
- The DC power wire must be fused at the battery positive (+) terminal connection. Before making or breaking power connections at the amplifier power terminals, disconnect the DC power wire at the battery end.
- The battery of the car audio system must be disconnected until the entire wiring and installation is completed.

CONTROL PANEL LAYOUT

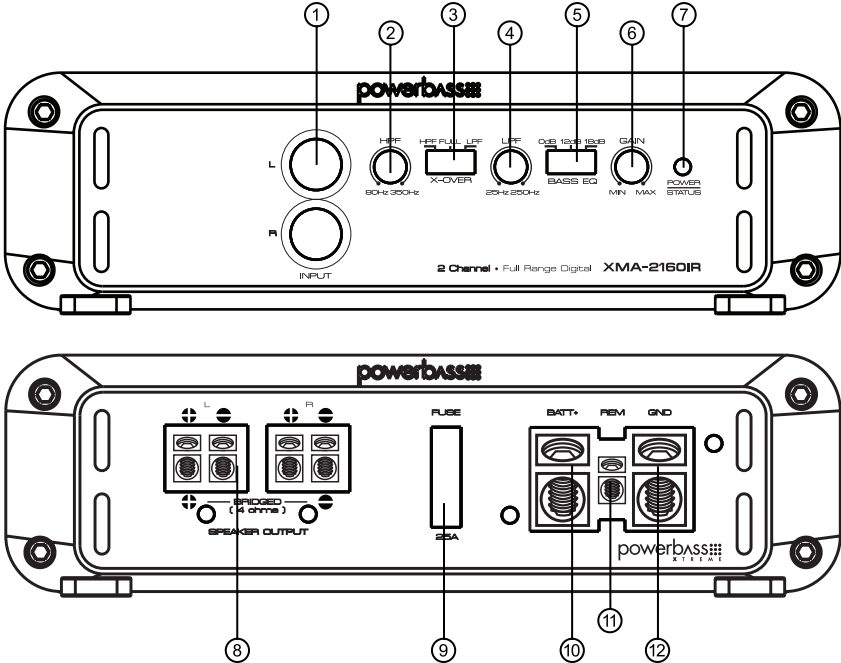

Fig.2 Panel Layout

NOTE: Panel Layout and Controls may differ by model.

1. Line INPUT (RCA) Jacks

These RCA style input jacks are for use with source units that have RCA line level outputs. A source unit with a minimum of 250mV is required for proper operation. However, this input will accept levels up to 6 Vrms.

2. HPF (High Pass Filter) Control

This control is continuously adjustable from 80Hz through 350Hz at 12dB per octave.

3. X-OVER Switch for LPF/FULL/HPF

Activates the built-in electronic crossover network. Works in conjunction with the LPF and HPF adjustable controls. When set to FULL, the two variable controls marked HPF and LPF have no effect on the amplifiers output.

4. LPF (Low Pass Filter) Control

This control is continuously adjustable from 25Hz through 250Hz at 12dB per octave.

5. BASS EQ Switch for 0dB/12dB/18dB

This equalization circuit is used to enhance the low frequency response of the vehicles interior. Selectable to 0dB (flat) or 12dB to 18dB of boost centered at 40Hz, the BASS EQ switch can be selected to meet your own personal tastes. Remember, more is not always better.

6. GAIN Control

This control is used to match the input sensitivity of the amplifier to the particular source unit that you are using.

7. POWER/STATUS Indicator

The clear LED lights Blue when the power is on—or turns Red constantly when the built-in protection circuitry is activated. Red indicates a problem with the system in relation to the amplifier. (See Troubleshooting Tips)

8. SPEAKER Output Terminals

This specially tooled solderless terminal block is designed to accommodate up to 10-gauge speaker wire. Please refer to the wiring diagrams in this manual and be sure to observe speaker polarity and impedance throughout the system.

9. FUSE(S)

For convenience most PowerBass AutoSound amplifiers utilize common automotive ATC type fuses. For continued protection in the event that a fuse blows, replace the fuse only with the same value (see specification table). **CAUTION: These power fuses on the amplifier chassis are for protecting the amp against overdrive. To protect the vehicles electrical system, an additional fuse should be used within 18-inches of the battery on the 12V+ cable.**

10. BATT+ (Power Input Connection)

This solderless terminal is the main power input for the amplifier and must be connected directly to the 12-volt Positive (+) terminal of the car battery. The terminal can accept up to 4-gauge wire (see Power Cable Selection Chart for the minimum recommended wire gauges).

11. REM (Remote Input Connection)

All PowerBass Xtreme amplifiers can be turned on by applying 12 volts to this terminal.

12. GND (Ground Input Connection)

A good quality ground is required for your PowerBass Xtreme amplifier to operate at peak performance. A short length of cable the same gauge as the Power cable should be used to attach the Ground terminal directly to the chassis of the vehicle. Make sure that all of the paint is sanded or scraped away to ensure a good ground connection.

POWER WIRING AND SIGNAL CONNECTIONS

*** WARNING ***

Disconnect the negative (-) battery terminal before you start any wiring work! The battery of your car audio system must be disconnected until the entire wiring installation is completed.

Your PowerBass Xtreme amplifier requires unrestricted current to deliver peak performance, so do not “starve” your amplifier by using small power cable. Using under sized power cable can result in unnecessary overheating of the amplifier, distortion at high volume levels and might even cause the thermal protection circuitry to shut-off the amplifier. Remember, bigger wire is better! For best results we recommend a PowerBass amplifier install kit, available at your local PowerBass dealer.

- Use rubber grommets when running cables through any metal or sharp plastic, to prevent accidental shorting or shearing. Make sure the cables do not interfere with normal operation of the vehicle.
- The audio signal cables (RCA interconnects) should be kept far away from any potential sources of electrical interference such as electronic vehicle management systems (relays, engine computers etc.), wiring harnesses, fuel pumps etc.

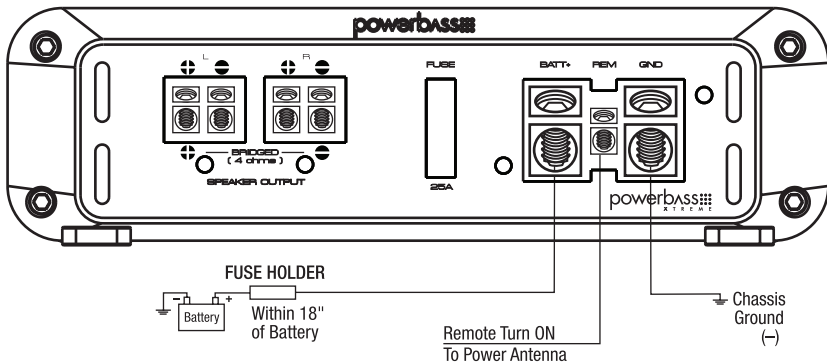

Fig.3 Power Input Connection

These amplifiers are designed to work within a 10 to 16 volt DC range. Before any wires are connected, the vehicles electrical system should be checked for correct voltage supply with the help of a voltmeter.

First, check the voltage at the battery with the ignition in the OFF position. The voltmeter should read no less than 12V. If your vehicles electrical system is not up to these specifications, we recommend having it checked by an auto electrician before any further installation. Once the vehicle is checked, make certain the correct cable gauge is used. The XMA amplifier terminals are capable of accepting up to 4 gauge power and ground cable. We recommend using as large a gauge cable as possible, use the Power Cable Selection Chart to calculate the correct power wire size for your application.

POWER WIRING

BATT+ (Power)

This amplifier should be wired directly to the vehicle battery using the appropriate size cable. Start at the vehicle battery and run the power cable through to the amplifier. Avoid running the power cable over engine components and near heater cores. **The use of an inline fuse or circuit breaker is a must;** this will prevent the risk of a potential fire caused by a short in your power cable. Connect the fuse holder or circuit breaker as close to the battery positive (+) terminal as possible (within 18" from the battery). This fuse or circuit breaker should be no greater then the sum of the fuses found on the chassis of your amplifier (also see specifications chart). You may now connect the cable to the battery, but remember to leave the fuse out or circuit breaker "off" until all other cable connections are made.

GND (Ground)

When grounding your amplifier, locate a metal area close to the amplifier that is good source of ground (preferable the floor pan). Use a short length of cable the same gauge as your power cable. Once again, investigate the area you wish to use for electrical wires, vacuum lines, and brake or fuel lines. Use either a wire brush or sandpaper to eliminate unwanted paint for better contact of the ground.

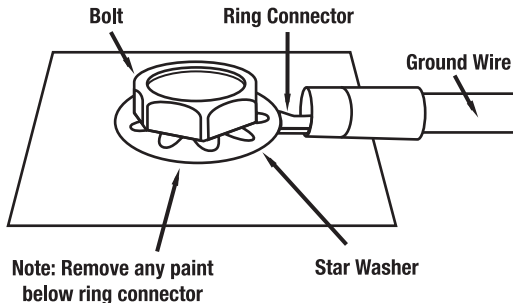

Secure the ground cable to the body using a bolt, star washer and nut. Spread silicon over the screw and bare metal to prevent rust and possible water leaks.

NOTE: The Ground must be capable of carrying the same amount of current as the positive wire.

Now it's time to connect the power and ground cables to the amplifier. Cut both cables to length. Strip off 1/2 inch (12mm) of the insulation so that the bare wire fits all the way in the terminal block on the side panel of the amplifier, seating it firmly so no bare wire is exposed. Use a screw driver to loosen the BATT+ and the GND connection on the amplifier. Insert the ground first, and then the +12V and please make sure that you place them into the correctly marked terminals. Hand tighten the set screws and make sure the connection is secure to prevent possible arcing due to loose screws.

REM (Remote Trigger)

This terminal must be connected to a switched +12V source. Typically, remote turn-on leads are provided at the source unit that will turn on and off the amplifier in correspondence with the source. If the source unit does not have a remote turn-on lead, then a power antenna wire can be used. If neither of these leads is available at the source unit, then a switched +12V supply must be used, like the ACC, +12V.

Run a minimum of 18 gauge wire from the amplifier location to the source of the switched +12V lead. If possible, route this wire on the same side of the vehicle as your power cable. Connect the source remote output to the wire. Go back to the amplifier and cut the wire to length. Loosen the screw terminal marked REM on the amplifier using an Allen wrench. Insert the stripped (bare) portion of the wire into the terminal and tighten the screw securely.

CONNECTIONS TO AMPLIFIER FOR BATT+, GND, REM AND SPEAKERS

Your PowerBass Xtreme amplifier features specially tooled solderless terminals for Power (BATT+), Ground, Remote, and Speaker connections. For maximum transfer of Voltage and Signal the bare wire needs to be inserted as far as possible into the terminal before tightening the set screw. For Power (BATT+) and Ground connections it is highly recommended that the bare ends of the wires are tinned with solder before inserting them into the terminal. Hand tighten the set screw and make sure the connection is secure to prevent possible arcing due to loose screws.

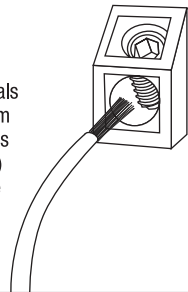

NOTE: It is highly recommended that an Allen wrench is used to tighten the set screws in the terminal blocks by hand and NOT a power drill. This will prevent stripping or other possible damage to the amplifier.

RCA INTERCONNECT

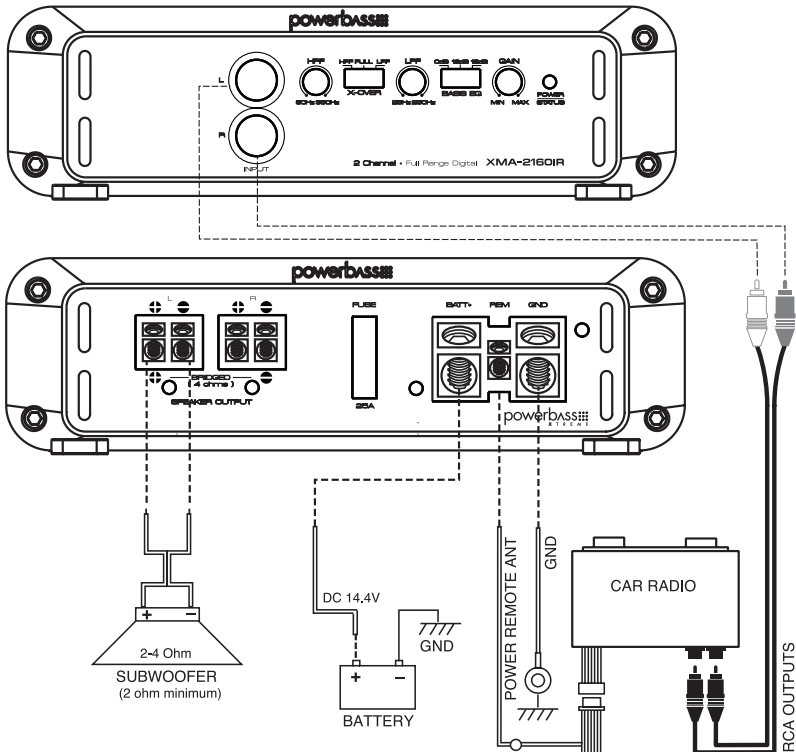

Fig.4 Low Level Input using RCA

Choose the correct length and style of RCA interconnects for your needs. Always use high quality RCA audio cables (not supplied) for signal connections—those with multiple layers of shielding or a twisted pair variety for better noise rejection.

Be extra careful when routing your RCA audio interconnect cables. Car environments are notorious for poorly insulated wires. This means that hiss, engine noise, and fan noise can easily be picked up through RCA cables if run incorrectly.

Make sure that the cables for power and audio signal are not on the same side of the vehicle and that they do not cross each other; this will help reduce any noise that may radiate from the power cable and the signal cable. If an audio cable is too close to a power cable, it may pick up the magnetic field generated by the power cable, which could lead to a loss of quality in your signal.

RCA INTERCONNECTS

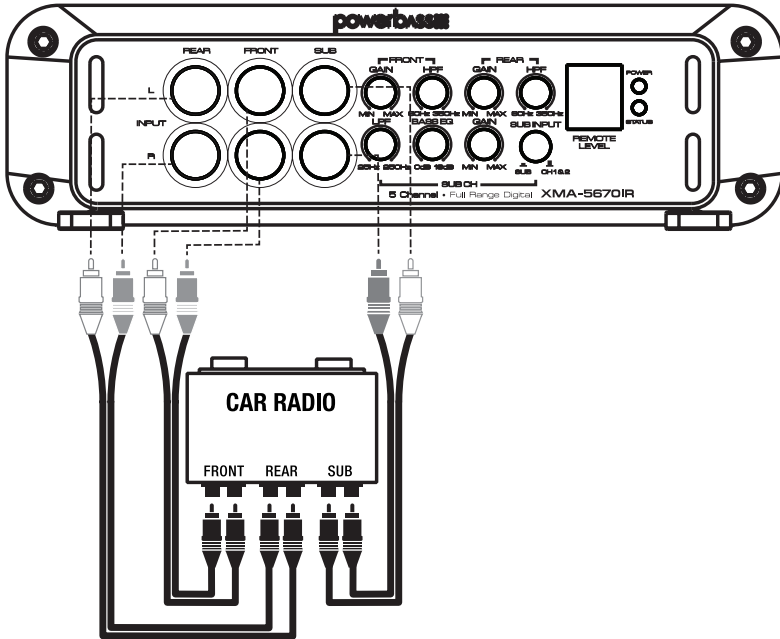

Fig.5 Low Level Input using RCA

Choose the correct length and style of RCA interconnects for your needs. Always use high quality RCA audio cables (not supplied) for signal connections—those with multiple layers of shielding or a twisted pair variety for better noise rejection.

Be extra careful when routing your RCA audio interconnect cables. Car environments are notorious for poorly insulated wires. This means that hiss, engine noise, and fan noise can easily be picked up through RCA cables if run incorrectly.

Make sure that the cables for power and audio signal are not on the same side of the vehicle and that they do not cross each other; this will help reduce any noise that may radiate from the power cable and the signal cable. If an audio cable is too close to a power cable, it may pick up the magnetic field generated by the power cable, which could lead to a loss of quality in your signal.

Single RCA OUT

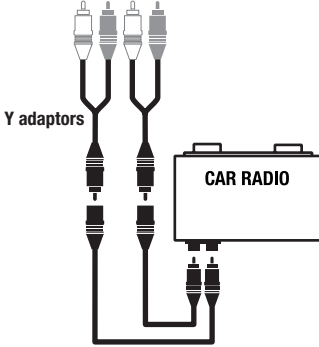
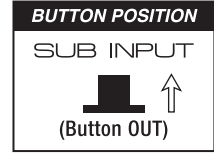
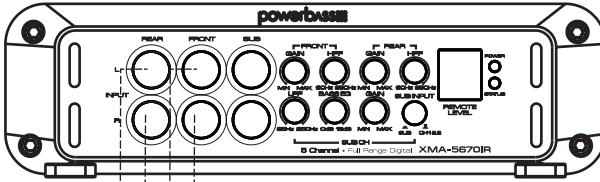

Single RCA Output on the Radio (Rear only)

In the event the car radio (head unit) you are using has only 1-set of RCA preamp outputs, you will need to split the signal using “Y” adaptors on the Right and Left channels as shown above. Since the radio's 2V (or possibly lower) pre out signal is split between 3 sets of inputs, the GAIN controls will need to be set considerably higher to maximize the amplifiers output. By doing this you will lose the Front to Rear fader capability as only the Rear RCA is being used.

Dual RCA OUT (Front and Rear)

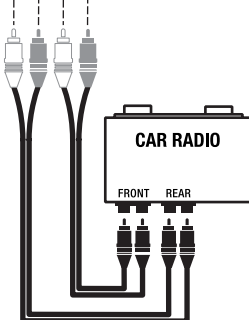
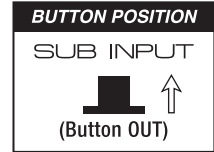
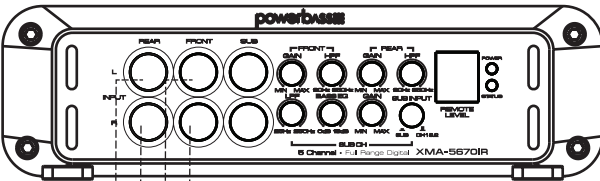

Dual RCA Output from the Radio (Front and Rear)

If the car radio (head unit) you are using has 2-sets of RCA preamp outputs you will retain the full balance and fade capabilities of your radio. With the SUB INPUT button “out” the subwoofer is unaffected by fade Front to Rear.

Three RCA OUT (Front and Rear plus Subwoofer)

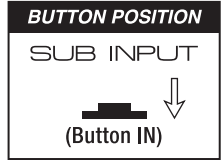
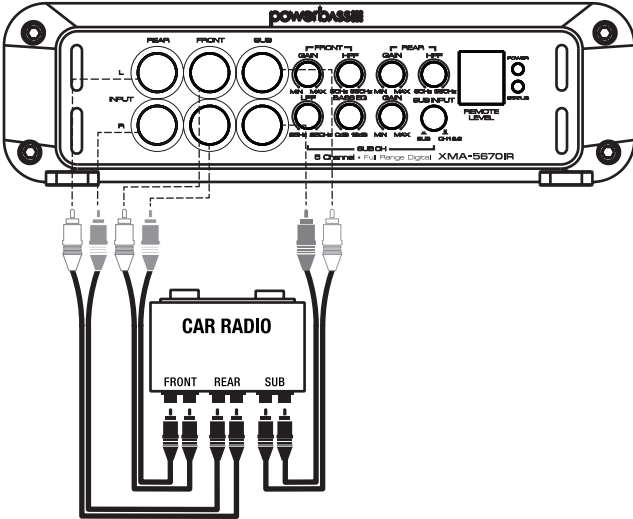

Three RCA Outputs from the Radio (Front and Rear plus Subwoofer)

This is the optimum configuration for this amplifier by providing 3-sets of discrete signal to the preamp. It will also offer the most flexibility in tuning the system.

SET UP ADJUSTMENTS

INPUT Gain Adjustment



Input Sensitivity Control

Fig.6 GAIN Control

This control allows you to match the input level of the amplifier to the output level of your head unit. Matching the input can be accomplished in three simple steps:

1. Set the volume of GAIN on the amplifier to Min (completely counter clock wise).
2. Turn on the head unit and adjust volume to 2/3 maximum, and set the BASS and TREBLE to zero.
3. Adjust the GAIN control clockwise until the sound **just begins** to distort, then back off slightly to cut distortion and operate at optimum gain.

Remember, the **GAIN control is not a volume control**. Ignoring the three steps above may leave you with damaged speaker and/or a damaged amplifier.

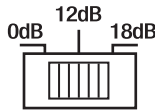

Fig.7 Bass EQ Control

BASS EQ Switch

This special feature is designed to provide you more powerful sound quality, and it allows you to boost the real Bass EQ up +18dB. The level of boost can be set to either 0 (no boost), +12dB or +18dB. Keep in mind that more is not always better! Setting the control to the max (18dB) can stress the amplifier and the speakers which may result in damage to your system.



Fig.8 High Pass Control (HPF)

HPF (High Pass Filter) Adjustment

When you are using coaxial or component speaker system, this allows you to adjust high-pass X-over frequency from 80Hz to 350Hz. To get better sound quality from coaxial or component speaker system, we recommend the frequency should be higher than 80Hz. Make sure the X-OVER switch is positioned at "HPF".



Fig.9 Low Pass Control (LPF)

LPF (Low Pass Filter) Adjustment

Using this volume, adjust the LPF frequency for your subwoofer speaker(s) operation. The X-OVER switch position should be at “LPF”.

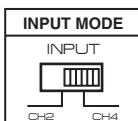

Fig.10 2 - 4 Channel Input Mode

Input Mode Switch (XMA-4160IR ONLY)

Matches the input from the Source Unit to that of the amplifier, either 2 or 4 Channel. This eliminates the use of “Y” adapters and provides a cleaner input signal.

SPECIAL CONTROLS FOR THE XMA 5670IR

The following instructions apply to the model XMA-5670IR only. You will not find these controls on any of the other models in this series.



Sub Input Button

The XMA-5670IR is a 5-channel amplifier that incorporates an advanced crossover network and a Subwoofer Remote Level control. You are able to select which of the 4 inputs that subwoofer signal is sourced to. With the Subwoofer Source button in the out position the subwoofer will receive its signal from a sum of the FRONT/REAR inputs. With the button in, the subwoofer signal will come from the SUB inputs.



BASS EQ Variable Control

This special feature is designed to provide you more powerful sound quality, and it allows you to adjust the Bass EQ up to 18dB at 45Hz. Keep in mind more is not always better. Setting the control to the max (18dB) may stress the amplifier and woofer and could result in damage.

SPEAKER WIRING AND CONFIGURATIONS

Speaker Load

Keep in mind your PowerBass Xtreme amplifier is a high power amplifier and not a high current amplifier. In other words **this amplifier requires a minimum impedance of 2 ohms STEREO and 4 ohms bridged MONO to operate trouble free.** Lower impedance will send the amplifier into protection and possibly damage the electronics inside and void the warranty.

NOTE: Know your total impedance load before you make any connections.

Speaker Wiring

Choose the correct speaker wire for your application. Most applications will require a minimum of 16 gauge wire. Route these using the same precautions as you did when you ran the power cable. Terminate these wires at the speaker end using insulated speaker terminals (not supplied) or by soldering the connection. Make sure the speaker connections are positive-to-positive and negative-to-negative. At the amplifier end, it is very important that the wires are making solid contact. Strip the wires insulation back approximately 1/2 inch (12mm) and insert the wires into the appropriate openings while being careful there are no loose or frayed strands of wire straying from the terminal. Check to make sure you've maintained proper polarity and balance.

CAUTION:

Maintaining proper impedance is critical when wiring the Full Range Digital model amplifiers. Improper wiring can cause severe damage to BOTH the woofer and the amplifier. Detailed wiring diagrams are supplied with all PowerBass woofers. IF YOU ARE NOT EXPERIENCED OR UNCOMFORTABLE READING THE WIRING DIAGRAMS CONSULT YOUR AUTHORIZED POWERBASS DEALER BEFORE YOU ATTEMPT TO WIRE THE SYSTEM.

Speaker Output Connections 2 Channel Model (XMA 2160IR)

1. 2-Channel Speaker Output Connection

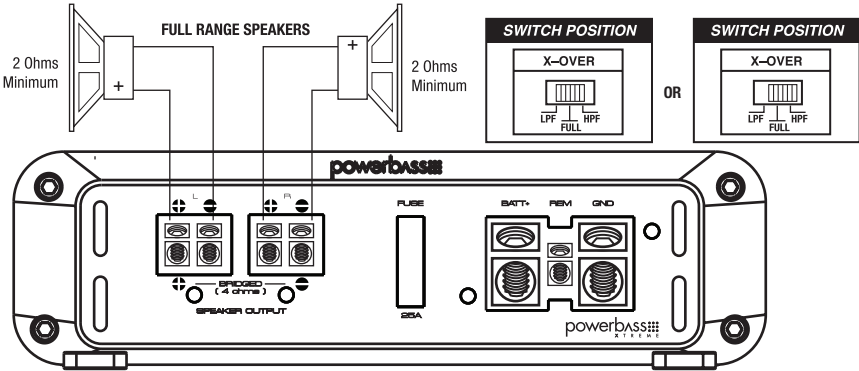

Fig.11 2-CH Speaker Connection
(Do not connect total impedance under 2 ohms)

2. 1-Channel (Bridged Mode) Speaker Output Connection

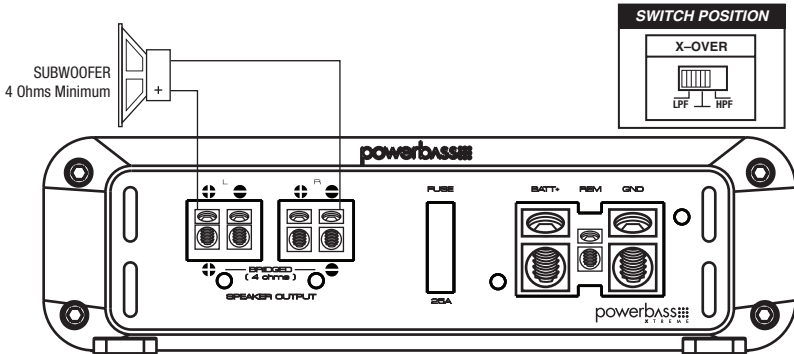

Fig.12 1-CH (Bridged Mode) Speaker Connection
(Do not connect total impedance under 4 ohms)

Tech Support
8:30am-5:30pm Pacific Time
(909) 923-3868
www.powerbassusa.com

Speaker Output Connections 4 Channel Model (XMA 4160IR)

3. 4-Channel Speaker Output Connection

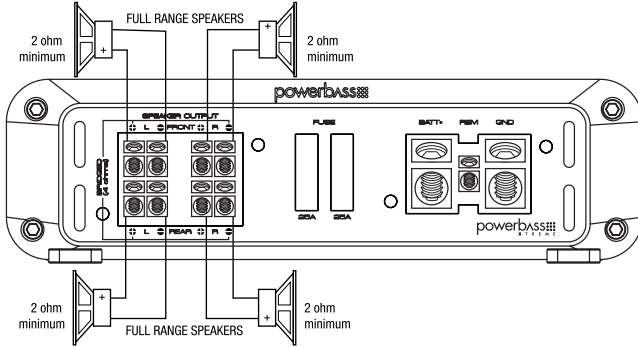
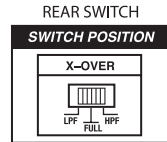
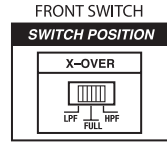

Fig.13 4-CH Speaker Connection / 2 ohms minimum



4. 3-Channel Stereo/Mono Speaker Output Connection

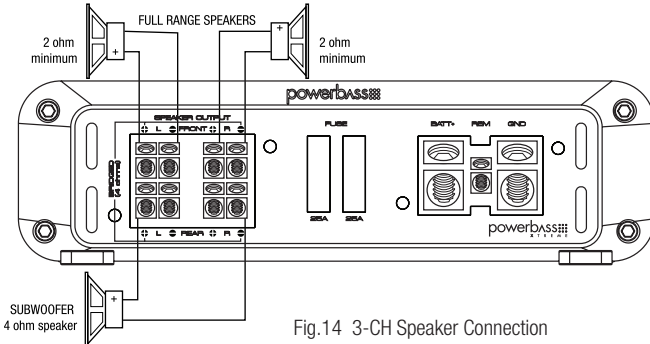
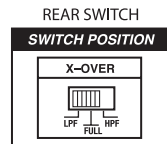
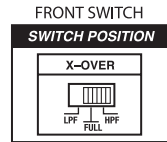

Fig.14 3-CH Speaker Connection



5. 2-Channel (Bridged Mode) Speaker Output Connection

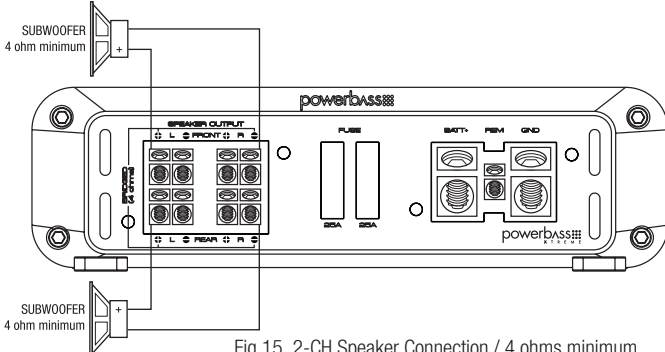
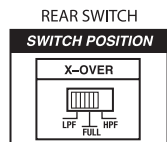
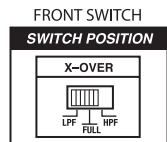

Fig.15 2-CH Speaker Connection / 4 ohms minimum



Speaker Output Connections 5 Channel Model (XMA 5670IR)

6. 5-Channel Speaker Output Connection

Tech Support
 8:30am-5:30pm Pacific Time
 (909) 923-3868
www.powerbassusa.com

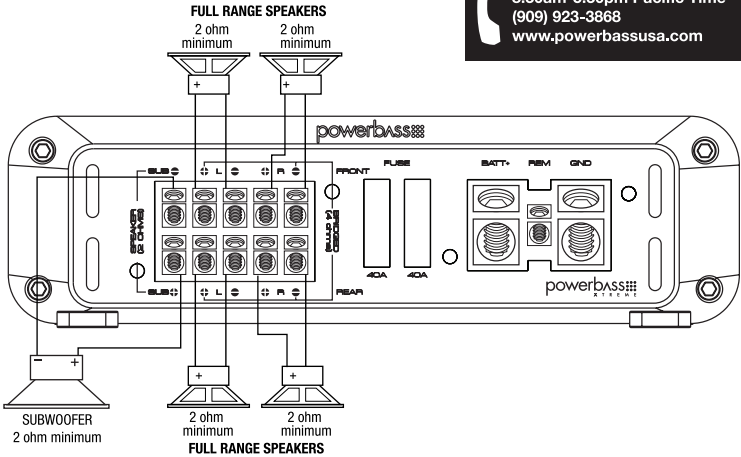

Fig.16 5-CH Speaker Connection / 2 ohms minimum

7. 3-Channel Speaker Output Connection

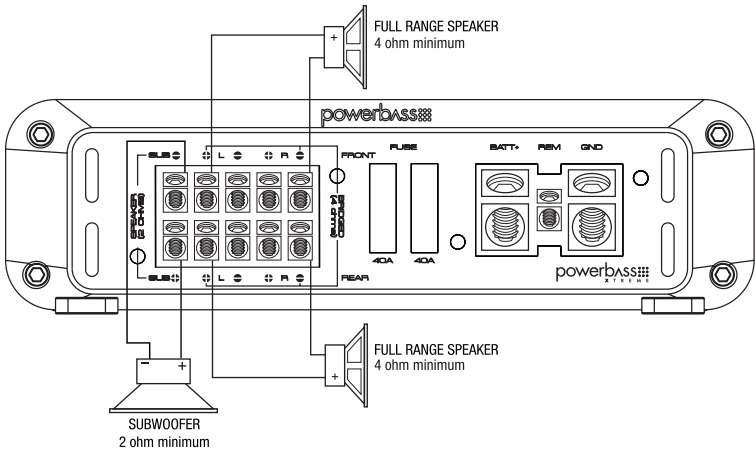

Fig.17 3-CH Speaker Connection

NOTES

RECOMMENDED WIRE SIZES

Power Cable Selection Chart							
Fuse Total	4Ft	4-7Ft	7-10Ft	10-13Ft	13-16 Ft	16-19 Ft	19-22 Ft
In Amperes	Length of Wire/Gauge						
150A - 200A	2 GA	2 GA	2 GA	*1/0*	*1/0*	*1/0*	*1/0*
125A - 150A	4 GA	4 GA	4 GA	4 GA	2 GA	2 GA	2 GA
105A - 125A	8 GA	8 GA	8 GA	4 GA	4 GA	4 GA	2 GA
85A - 105A	8 GA	8 GA	8 GA	4 GA	4 GA	4 GA	4 GA
65A - 85A	10 GA	8 GA	8 GA	8 GA	4 GA	4 GA	4 GA
50A - 65A	10 GA	10 GA	8 GA	8 GA	8 GA	8 GA	8 GA
35A - 50A	10 GA	10 GA	10 GA	8 GA	8 GA	8 GA	8 GA
25A - 35A	10GA	10GA	10GA	10GA	8GA	8GA	8GA

PowerBass makes several types of amplifier wiring kits to assist with the installation of your PowerBass amplifier. Consult your local PowerBass dealer for details. For more information about recommended power wire check out our website at www.powerbassusa.com.

PERSONAL NOTES:

Name: _____

Date Purchased: _____

Dealer: _____

Installed By: _____

Model: _____

Serial Number: _____

Miscellaneous: _____

This manual is the exclusive property of PowerBass USA, Inc. Any reproduction of this manual, or use other than its intentions is strictly prohibited without the express consent of PowerBass USA, Inc. © Copyright 2013 PowerBass USA, Inc.

TROUBLESHOOTING TIPS

Problem	Solution
Power LED not ON	<p>With a Volt Ohm Meter (VOM) check:</p> <ul style="list-style-type: none"> • +12 Volt power terminal (should read +12 to +16VDC) • Remote turn-on terminal (should read +12 to +16VDC) • Ground Terminal
Power LED lights BLUE, no output	<ul style="list-style-type: none"> • Check RCA connections • Test speaker outputs with known good speaker • Substitute known good Source Unit • Check for signal on the RCA cable with VOM in AC position
Power LED lights BLUE, but volume reduces automatically.	<ul style="list-style-type: none"> • Advanced Protection Circuitry is engaging due to high internal temperature of the amplifier. Amplifier requires more air flow around the chassis. If this continues choose a better ventilated mounting location. • High operating temperature can be caused by incorrect input sensitivity level. Reset the GAIN control.
Red Status Protection LED is ON, no output and 1. Amp is VERY HOT 2. Amp shuts down ONLY when the vehicle is running 3. Amp plays at very low volume	<ul style="list-style-type: none"> • Thermal protection is engaged. Check for proper impedance at speaker terminals. Also check for adequate air flow around the amplifier. • Voltage protection engaged. Voltage to the amp is not within the 10-16 VDC operating range. Have the battery/charging system inspected. • Short circuit protection is engaged. Check for speaker wires shorted to each other or the vehicle chassis. Speakers operating below the minimum impedance can cause this to occur.
Alternator noise (varies with RPM)	<ul style="list-style-type: none"> • Check for damaged RCA cable. • Check routing of RCA cable • Check Source Unit for good ground • Check amp gain setting, turn down if set too high
Poor Bass Response	<ul style="list-style-type: none"> • Check speaker polarity, reverse the connection of one speaker only.

NOTE: If the Status L.E.D. is activated and glows RED with no speakers connected to the amplifier, and all the power connections are correct, this would indicate an internal problem with the amplifier. Contact PowerBass USA or your local dealer.

SPECIFICATIONS FOR XTREME MINI AMPLIFIER

Two Channel Model	XMA-2160IR	XMA-2400IR
4 Ohms Power (Watts)	80 x 2	200 x 2
2 Ohms Power (Watts)	160 x 2	2 x 400
4 Ohms Mono Power (Watts)	320 x 1	800 x 1
Peak Music Power (Watts)	640	1600
THD @ RMS Power	< 0.2%	< 0.2%
Frequency Response	10Hz - 40kHz	10Hz - 40kHz
S/N Ratio (EIA Rated)	> 90dB	> 90dB
Input Sensitivity	250mV - 6.0 volts	250mV - 6.0 volts
Crossover Slope	12dB	12dB
High-Pass Crossover Freq. (Hz)	80Hz - 350Hz	80Hz - 350Hz
Low-Pass Crossover Freq. (Hz)	25Hz - 250Hz	25Hz - 250Hz
Selectable Subwoofer EQ	0 / 12dB / 18dB	0 / 12dB / 18dB
Subwoofer EQ Freq.	45Hz	45Hz
Fuses/ ATC Style	25A x 1	30A x 2
Dimension	2.0" x 7.1" x 7.6"	2.0" x 7.1" x 9.1"

Four Channel Model	XMA-4160IR
4 Ohms Power (Watts)	80 x 4
2 Ohms Power (Watts)	160 x 4
4 Ohms Mono Power (Watts)	320 x 2
Peak Music Power (Watts)	1280
THD @ RMS Power	< 0.2%
Frequency Response	10Hz - 40kHz
S/N Ratio (EIA Rated)	>90dB
Input Sensitivity	250mV - 6.0 volts
Crossover Slope	12dB
High-Pass Crossover Freq. (Hz)	80Hz - 350Hz
Low-Pass Crossover Freq. (Hz)	25Hz - 250Hz
Selectable Subwoofer EQ	0 / 12dB / 18dB
Subwoofer EQ Freq.	45Hz
Fuses/ ATC Style	25A x 2
Dimension (52 x 180 x 262mm)	2.0" x 7.1" x 10.3"

SPECIFICATIONS FOR XTREME MINI AMPLIFIER Cont.

Five Channel Model	XMA 5670IR
4 Ohms Stereo Power (Watts)	80 x 4 + 250 x 1
2 Ohms Stereo Power (Watts)	160 x 4 (2 ohm) + 320 x 1 (2 ohm)
4 Ohms Mono Power (Watts)	320 x 2 + 320 x 1
Peak Music Power (Watts)	1920
THD @ RMS Power	< 0.2%
Frequency Response	10Hz - 40kHz
S/N Ratio (EIA Rated)	> 90dB
Input Sensitivity	250mV - 6.0 volts
Crossover Slope	12dB
High-Pass Crossover Freq. (Hz)	80Hz - 350Hz
Low-Pass Crossover Freq. (Hz / Sub Out only)	25Hz - 250Hz
Variable Subwoofer EQ	0 - 18dB
Subwoofer EQ Freq.	45Hz
Fuses/ ATC Style	40A x 2
Dimension (52 x 180 x 302mm)	2.0" x 7.1" x 11.9"

Important Notes:

- **Due to continuing improvements these specifications are subject to change without any notice.**
- **Do not attempt to fix or repair this unit. Unauthorized repairs will void the manufacturer's warranty.**

POWERBASS ELECTRONICS LIMITED WARRANTY POLICY

PowerBass USA, Inc. offers limited warranty on PowerBass products under normal use on the following terms:

PowerBass Xtreme Amplifiers are to be free of defects in material and workmanship for a period of one (1) year.

This warranty applies only to PowerBass products sold to consumers by Authorized PowerBass Dealers in the United States of America. Products purchased by consumers from a PowerBass dealer in another country are covered only by that country's Distributor and not by PowerBass USA.

This warranty covers only the original purchaser of PowerBass product. In order to receive service, the purchaser must provide PowerBass with the receipt stating the consumer name, dealer, product and date of purchase.

Products found to be defective during the warranty period will be repaired or replaced (with a product deemed to be equivalent) at PowerBass's discretion and will not be liable for incidental or consequential damages. PowerBass will not warranty this product under the following situations:

- **Amplifiers received with apparent rust or corrosion**
- **Any evidence of liquid damage or exposure to excessive heat**
- **Attempted repairs or alterations of any nature**
- **Product that has not been installed according to this owners manual**

Any implied warranties including warranties of fitness for use and merchantability are limited in duration to the period of the express warranty set forth above. Some states do not allow limitations on the length of an implied warranty, so this limitation may not apply. No person is authorized to assume for PowerBass any other liability in connection with the sale of this product.

Please call (909) 923-3868 for PowerBass Customer Service. You must obtain an RA# (Return Authorization Number) to return any product to PowerBass. The RA number must be prominently marked on the outside of the shipping carton or the delivery will be refused. Please pack your return carefully; we are not responsible for items damaged in shipping. Return the defective product along with a copy of the original dated retail sales receipt, plus \$12.00 for handling and diagnostic evaluation to:

**PowerBass USA, Inc.,
Attn: Returns (RA# _____)
2133 S. Green Privado, Ontario, CA 91761**

Residents of HI, AK and US territories will be charged for return shipping. All inquires regarding service and warranty should be sent to the above address.

Removed or altered serial numbers will void this warranty



PowerBass Xtreme – A division of PowerBass USA, Inc.
2133 S. Green Privado – Ontario, CA 91761
Tel. (909) 923-3868 – Fax (909) 923-8048
www.powerbassusa.com